



GM 6T40 (GEN. 1), 6T45 (GEN. 1), 6T50 (GEN. 1) ZIP KIT®

PART NUMBER 6T40-ZIP

QUICK GUIDE

Parts are labeled here in order of installation. See other side of sheet for details on Zip Kit contents.

INSTALLATION DIAGRAM



NOTE: All components of this kit install into the mechatronic unit, and not the pump. Removal of the pump is not required for this kit, unless vacuum testing is to be performed.

Control Valve Body

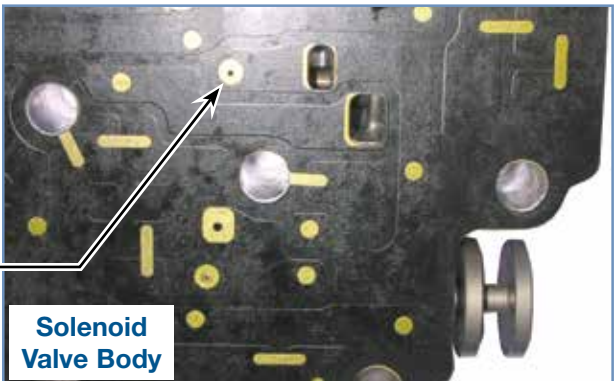
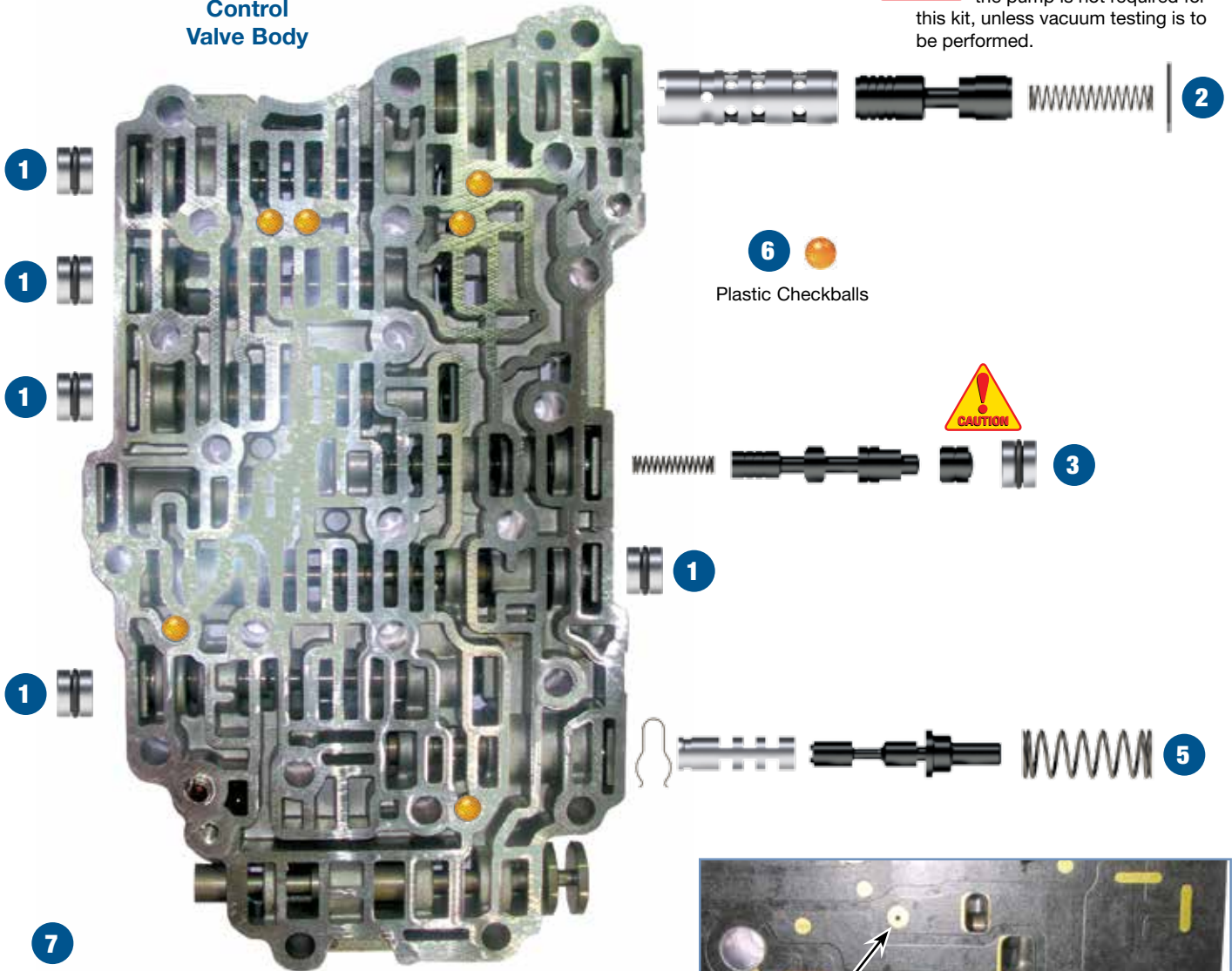

Solenoid Valve Body

4 Block AFL Balance Port by drilling and plugging separator plate where indicated using drill bit and aluminum plug provided (not shown).

WARNING: Spacers should not be used on TEHCMs that have plastic fluid conduits.

NOTE: Reference pages 3 and 4 in the technical booklet for installation details.



In addition to general rebuilding tips and technical information, the technical booklet included in this kit contains vacuum testing and additional repair options for higher mileage units or for repairing specific complaints which are beyond the scope of this kit.

Zip Kit Contents & Installation Steps

Step 1 Replace 5 OE End Plugs

Place O-ring in groove, lubricate with Sonnax Slippery Stick™ O-LUBE and roll on bench to size.

Packaging Pocket 1

- End Plugs (5)
- O-Rings (7) 2 extra

Step 2 Replace OE Compensator Feed Regulator Valve

Packaging Pocket 2

- Valve
- Sleeve
- Spring
- Retainer

Step 3 Replace TCC Regulator Apply Valve Bore Lineup

Remove and discard all OE components except the retainer clip. Keep retainer clip for reuse.



CAUTION: The small shuttle valve should be positioned with the rounded end face outboard, and the blind bore inboard.

Packaging Pocket 3

- Spring
- Valve
- Shuttle Valve
- End Plug
- O-Rings (2) 1 extra

Step 4 Block AFL Balance Port

Drill indicated separator plate orifice with included .062" dia. drill bit. Remove any burrs. Insert .062" dia. aluminum plug into drilled hole and peen in place on both sides of plate. Ensure plate will still fit flush on both castings.

Packaging Pocket 4

- Drill Bit, .062" dia.
- Aluminum Plugs, .062" dia. (2) 1 extra



CAUTION: Use care when modifying the balance orifice. Gaskets are bonded to the plates and damage could occur.

Step 5 Replace OE Actuator Feed Limit (AFL) Valve Lineup

Remove and discard OE valve and spring. Keep outboard retainer clip for reuse. Install Sonnax sleeve and valve as illustrated. Secure sleeve into bore by installing included clip into sleeve groove at inboard port. Install included spring and secure all into bore with OE retainer.

Packaging Pocket 5

- Sleeve
- Valve
- Spring
- Retainer Clip

Step 6 Replace OE Checkballs

Packaging Pocket 6

Checkballs, .250" dia. (6)

Step 7 Replace 4 Pressure Switch Laminate Discs & D-Rings (& O-Rings when applicable)

Reference pages 3 and 4 in the technical booklet for installation details.

Packaging Pocket 7 and 8

- Laminated Discs (4)
- D-Rings (4)
- O-Rings (4)
- Spacers (4)



WARNING: Spacers should not be used on TEHCMS that have plastic fluid conduits.



GM 6T40 (GEN. 1), 6T45 (GEN. 1), 6T50 (GEN. 1) ZIP KIT®

PART NUMBER 6T40-ZIP

INSTALLATION & TESTING BOOKLET

Valve Body Identification

Confirm Generation

This Zip Kit works in Generation 1 6T40 series valve bodies. To confirm core is a Generation 1 versus a Generation 2, check for 4-5-6 clutch boost valve in control valve body (**Figures 1 & 2**).

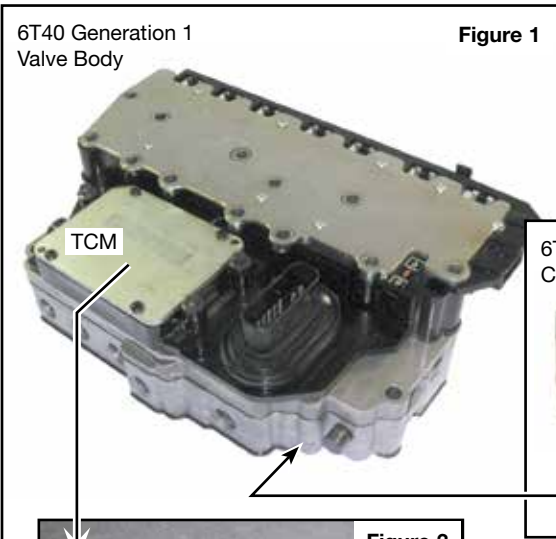

Figure 1

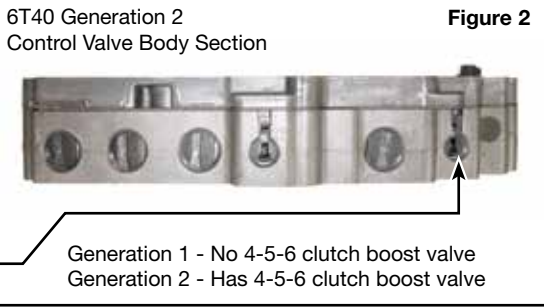

Figure 2

Generation 1 - No 4-5-6 clutch boost valve
Generation 2 - Has 4-5-6 clutch boost valve

Also check the Transmission Control Module (TCM) identifications as shown in (**Figures 3 & 4**). The valve body and TCM must have the same Generation.

Adaptive Learning

The 6T40, 6T45 and 6T50 are equipped with several adaptive learning strategies. After valve body service the existing adaptive values will need to be erased. Then, a "Fast Learn" process should be performed. Reference GM material for proper "Fast Learn" process.

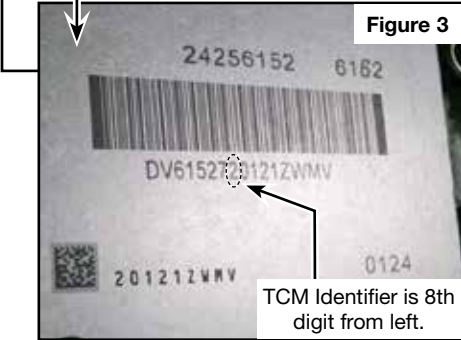

Figure 3

TCM Identifier is 8th digit from left.

TCM Identifier	Figure 4
Generation 1	1 or 2 or 3
Generation 2	B or C or D

Solenoids

The Generation 1 6T40, 6T45 and 6T50 solenoids are Variable Bleed Type (VBS) and cannot be interchanged with Generation 2 solenoids. These are calibrated at the factory and switching locations in the valve body should be avoided. Different suppliers were used, resulting in different solenoid plastic snout colors. Colors are black, blue, yellow and natural.

Solenoid & Clutch Apply Chart

Figure 5

Range/Gear	Shift Solenoid	1-2-3-4 CL PC Sol 5 N.L.	2-6 Cl. PC Sol 4 N.L.	3-5 Rev. Cl. PC Sol 2 N.H.	Low Rev. 4-5-6 CL PC Sol 3 N.H.	4-5-6 Clutch	3-5 Reverse Clutch	2-6 Clutch	Low & Rev. CL (OWC)	Low & Rev. Clutch	1-2-3-4 Clutch
Park	On	Off	Off	Off	On					Applied*	
Reverse	On	Off	Off	On	On		Applied			Applied	
Neutral	On	Off	Off	Off	On					Applied*	
Drive	1st Breaking	On	On	Off	Off	On			Holding†	Applied	Applied
	1st	Off	On	Off	Off	Off			Holding		Applied
	2nd	Off	On	On	Off	Off		Applied			Applied
	3rd	Off	On	Off	On	Off		Applied			Applied
	4th	Off	On	Off	Off	On	Applied				Applied
	5th	Off	Off	Off	On	On	Applied	Applied			
6th	Off	Off	On	Off	On	Applied		Applied			

NOTE: For shift solenoids, "ON" = solenoid energized (pressurized), "OFF" = solenoid de-energized (no pressure). For pressure control (PC) solenoids, "ON" = pressurized, "OFF" = no pressure. *Applied with no load. †Holding but ineffective.

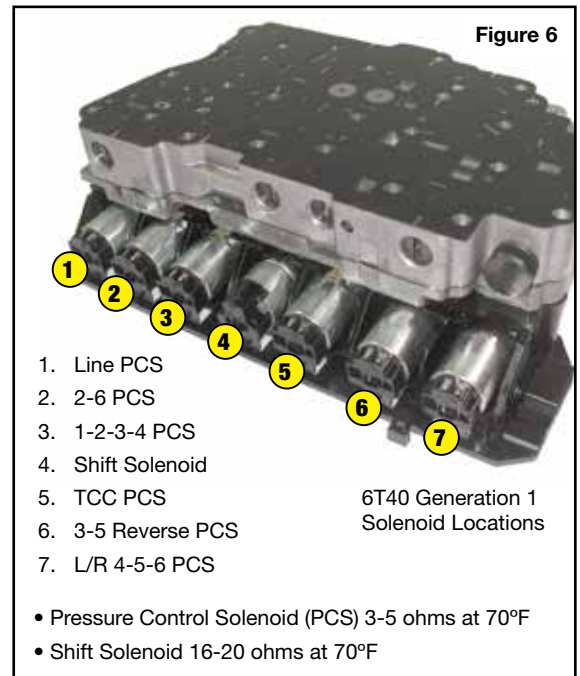

Figure 6

1. Line PCS
2. 2-6 PCS
3. 1-2-3-4 PCS
4. Shift Solenoid
5. TCC PCS
6. 3-5 Reverse PCS
7. L/R 4-5-6 PCS

6T40 Generation 1 Solenoid Locations

- Pressure Control Solenoid (PCS) 3-5 ohms at 70°F
- Shift Solenoid 16-20 ohms at 70°F

Zip Kit Instructions

1. Valve Body Removal from Case

- Disconnect the input speed sensor, output speed sensor and shift position switch connectors from valve body.
- Remove the three control valve body bolts, 40.5mm long (**Figure 7**).
- Remove the 12 control valve body bolts, 105mm long (**Figure 7**).
- Remove the control solenoid valve assembly with TCM from valve body.
- Remove the nine control valve body bolts, 60mm long (**Figure 8**).
- Remove the two control valve body bolts, 53mm long (**Figure 8**).
- Remove the valve body from the case.

2. Installation

Install Zip Kit parts as shown on diagram of separate quick guide sheet included in this Zip Kit. Sonnax recommends vacuum testing critical wear areas not covered by this kit to determine whether additional Sonnax parts are required (see page 3).

3. Filter Plate & Pressure Switches (**Figure 12**)

NOTE: Keep the filter plate clear from any solvents, as distortion to the seals could occur.

- Remove and replace the filter plate. The seals take a set and will leak if reused.
- Examine the pressure switches and seals for damage or contamination. Fracture or delamination of the pressure switch laminate disc can occur, requiring seal and laminate displacement.

4. Valve Body Reinstall into Case

- Install valve body into case and secure with (2x) 53mm and (9x) 60mm bolts until finger-tight (**Figure 8**).
- Tighten to 106 in-lbs of torque in the indicated sequence (**Figure 10**).
- Install control solenoid body to valve body with (12x) 105mm and (3x) 40.5mm bolts until finger-tight (**Figure 7**).
- Tighten (12x) 105mm bolts to 106 in-lb of torque in the indicated sequence (**Figure 11**).
- Tighten the (3x) 40.5mm bolts to 71 in-lb torque in the indicated sequence.
- Reconnect the input speed sensor, output speed sensor and shift position switch connectors (**Figure 7**).

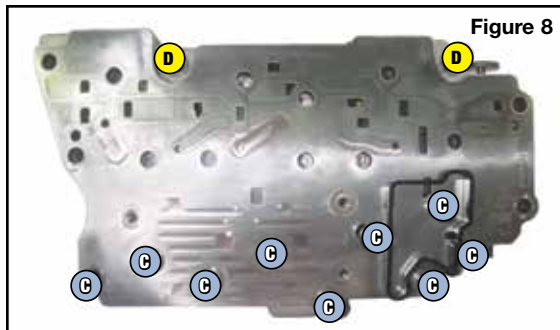
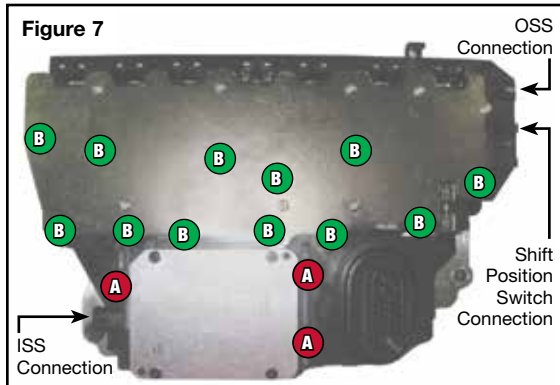

Removal Bolts

Figure 9

Bolt Color Code	Bolt Length	Quantity	Torque Specification
A Red	40.5mm	3	71 in-lb
B Green	105mm	12	106 in-lb
C Blue	60mm	9	106 in-lb
D Yellow	53mm	2	106 in-lb

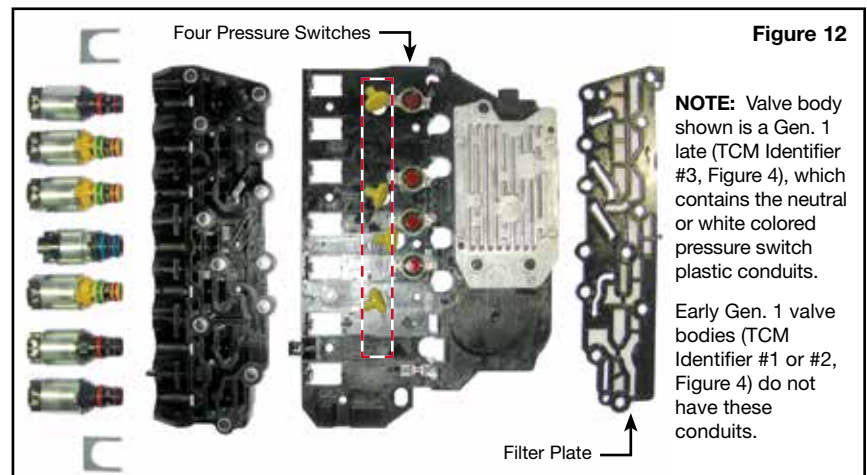
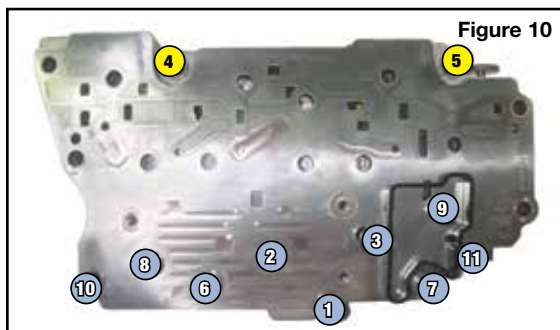

Installing Sonnax Pressure Switch Rebuild Kit

GM first generation 6T40, 6T45, and 6T50 transmissions often set various trouble codes related to failures of fluid pressure switches that are internal to the transmission control module (TCM). These codes may be accompanied by shift irregularities such as slipping, flares, harsh application, and bindups.

As time goes by, the laminated portions of the pressure switches can breach, preventing normal switch operation. If more than one switch breaks down, failsafe mode can be triggered.

1. Disassembly

- a. Remove retaining screws and detach solenoid body cover plate (Figure 13).



NOTE: Before installing Sonnax pressure switch rebuild kit, test switches to verify proper electrical operation.

Place ohmmeter leads on each side of pressure switch, outside of the rivet (Figure 14). Switches are normally closed and should read from about 2.2 to 2.8 ohms in their non-operated state. Pressing on the switch opens the contacts and should result in O.L. reading. If these tests fail, test resistance again at the switch side, before the rivet; loose rivets can cause circuit interruption. If testing is successful, proceed with installation of Sonnax kit.

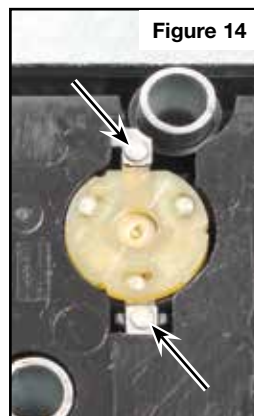

Figure 14

- b. Separate solenoid body from TCM (Figure 15). Four pressure switch laminate discs are now exposed on underside of TCM (Figure 16).
- c. Remove D-rings from switches and discard (Figure 17).
- d. Using a pencil eraser dabbed with assembly gel, remove OE laminate discs from switches and discard (Figure 18).

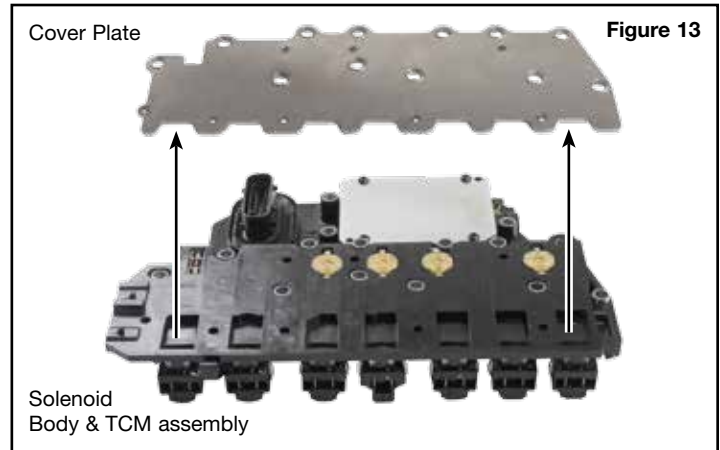

Figure 13

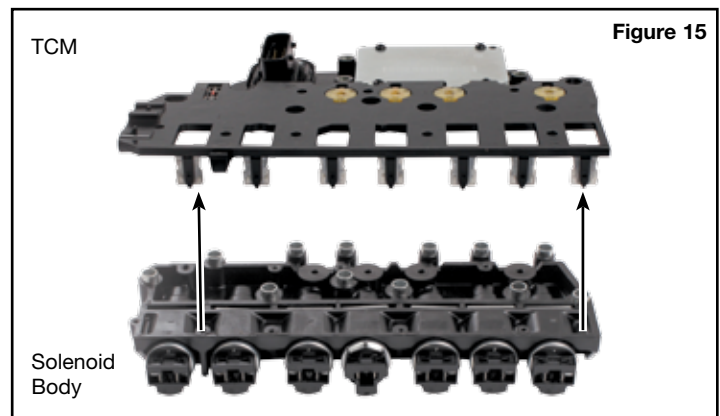

Figure 15

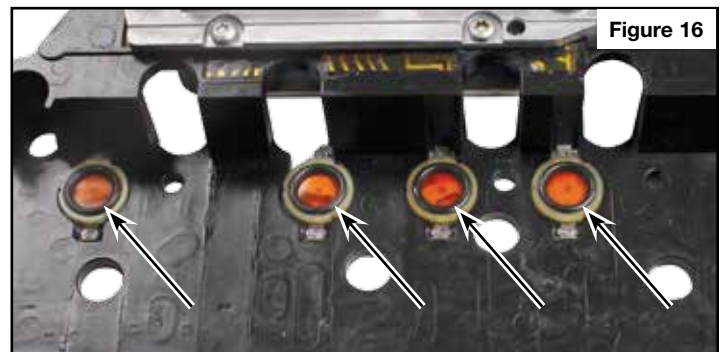

Figure 16



Figure 17

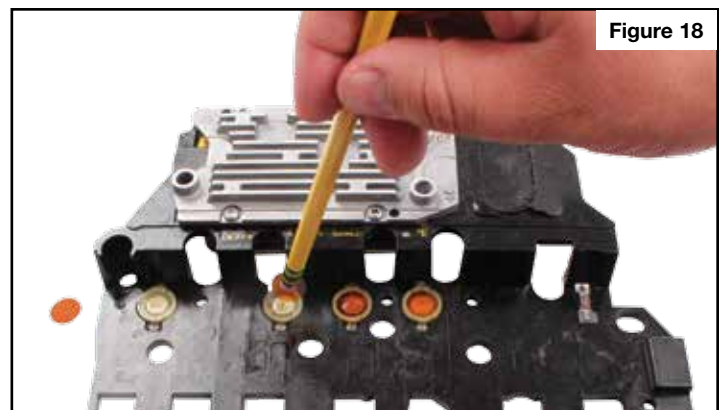

Figure 18

2. Installation & Assembly

- a. Ensure any dirt or debris is cleaned from switches before proceeding.
- b. Place Sonnax laminate discs on switches.
- c. Install Sonnax D-rings over laminate discs, flat side facing down. D-rings have slight interference fit; ensure they fit snugly into switch (Figure 19).



NOTE: Some solenoid bodies are equipped with plastic fluid conduits (Figure 20). If so equipped, remove conduits to expose O-rings (Figure 21). Replace O-rings with Sonnax O-rings and reinstall conduits.

- d. Reinstall solenoid body to TCM (Figure 22).



WARNING: Steps "e" and "f" apply only to units that DO NOT have plastic fluid conduits.

- e. Turn assembly to expose back side of switches (Figure 23).
- f. Place Sonnax spacers over switches. A dab of assembly lube will help keep them in place during reassembly (Figure 24). These spacers assist in keeping appropriate support on switches to provide a good seal and prevent over-flexing, which is vital to maintaining proper switch function.



WARNING: Do NOT install Sonnax spacers into units equipped with plastic fluid conduits!

- g. Reinstall solenoid body cover plate and secure with retaining screws (Figure 13).

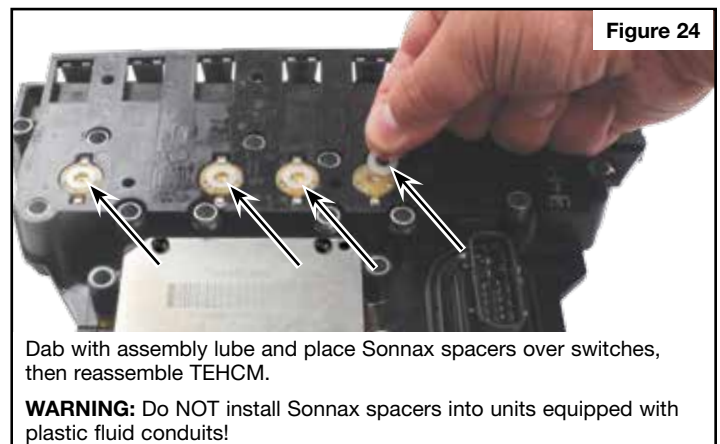
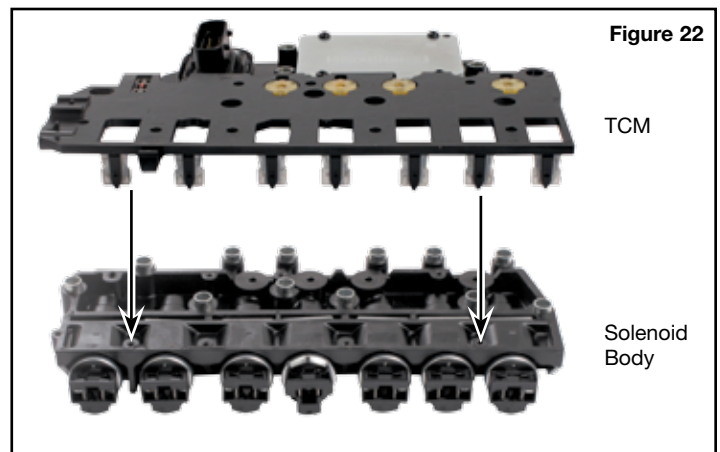
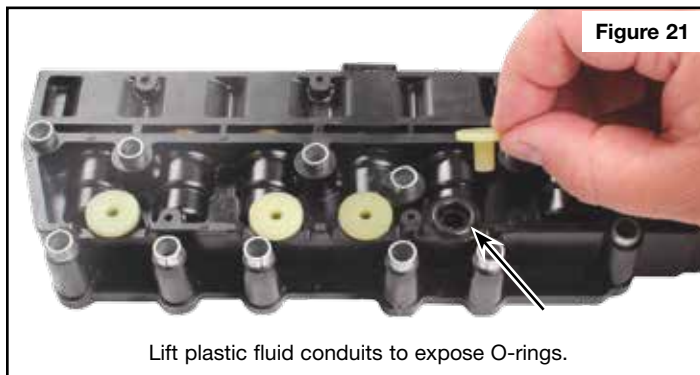
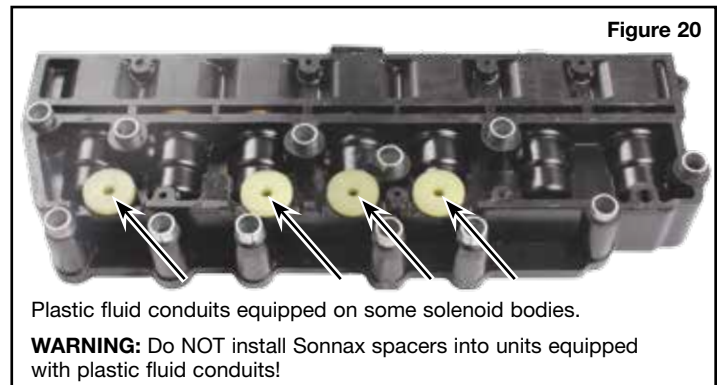

Critical Wear Areas & Vacuum Test Locations

NOTE: OE valves are shown in rest position and should be tested in rest position unless otherwise indicated. Test locations are pointed to with an arrow. Springs are not shown for visual clarity. Low vacuum reading indicates wear and Sonnax parts noted for replacement.

Control Valve Body – Front • Gen. 1 6T40 Shown

3-5 Reverse Clutch Regulator Valve

- Burnt 3-5 reverse clutch
- Delayed Reverse
- 3rd & 5th Shift complaints
- 2-3 & 4-5 Shift flare

*Plug port on back.

*Plug port on back.

Compensator Feed Regulator Valve

- Harsh shifts; CPC codes
 - Bump up/down shifts
 - Erratic shift quality
- Replace with Sonnax Part No. 104740-09K***

1-2-3-4 Clutch Regulator Valve

- Burnt 1-2-3-4 clutch
- Delayed Forward
- 1-2-3-4 Shift complaints

2-6 Clutch Regulator Valve

- Burnt 2-6 clutch
- 2nd & 6th Shift complaints
- 1-2 & 5-6 Shift flare

*Plug port on back.

1-2-3-4 Clutch Boost Valve

- Burnt 1-2-3-4 clutch
 - Delayed Forward
 - 1-2-3-4 Shift complaints
- Replace with Sonnax Part No. 144740-22** Requires F-144740-TL21 & VB-FIX

TCC Regulator Apply Valve

- No TCC/slip, soft apply
 - Harsh TCC apply
- Replace with Sonnax Part No. 144740-16K**
Requires F-144740-TL16 & VB-FIX

Low Reverse 4-5-6 Clutch Regulator Valve

- Burnt L/R & 4-5-6 clutch
- Delayed Reverse
- 4-5-6 Shift complaints
- 3-4 Shift flare

*Plug port on back.

*Plug port on back.

Clutch Select Valve

- Various shift complaints
- Shift related trouble codes

***Note:** Plug casting valley with foam, putty or appropriately sized O-ring coated in assembly lube to isolate circuit.

Actuator Feed Limit Valve

- Harsh shifts
 - No/Slipping shifts
 - Low clutch pressure
- Replace with Sonnax Part No. 144740-01** Requires 144740-TL

Control Valve Body – Back Gen. 1 6T40 Shown

*Plug these ports (as noted above) while vacuum testing.

O-Ringed End Plugs

- Burnt clutches/brakes
 - Various shift complaints
- NOTE:** Vacuum test end plugs at outboard port while sealing bore opening with thumb.

Replace with Sonnax Part No. 144740-02K*

NOTE: Several Locations = ★

Part numbers with an asterisk () are included in this Zip Kit.

Critical Wear Areas & Vacuum Test Locations

NOTE: OE valves are shown in rest position and should be tested in rest position unless otherwise indicated. Test locations are pointed to with an arrow. Springs are not shown for visual clarity. Low vacuum reading indicates wear and Sonnax parts noted for replacement.

Pump Body • Gen. 1 6T40 Shown

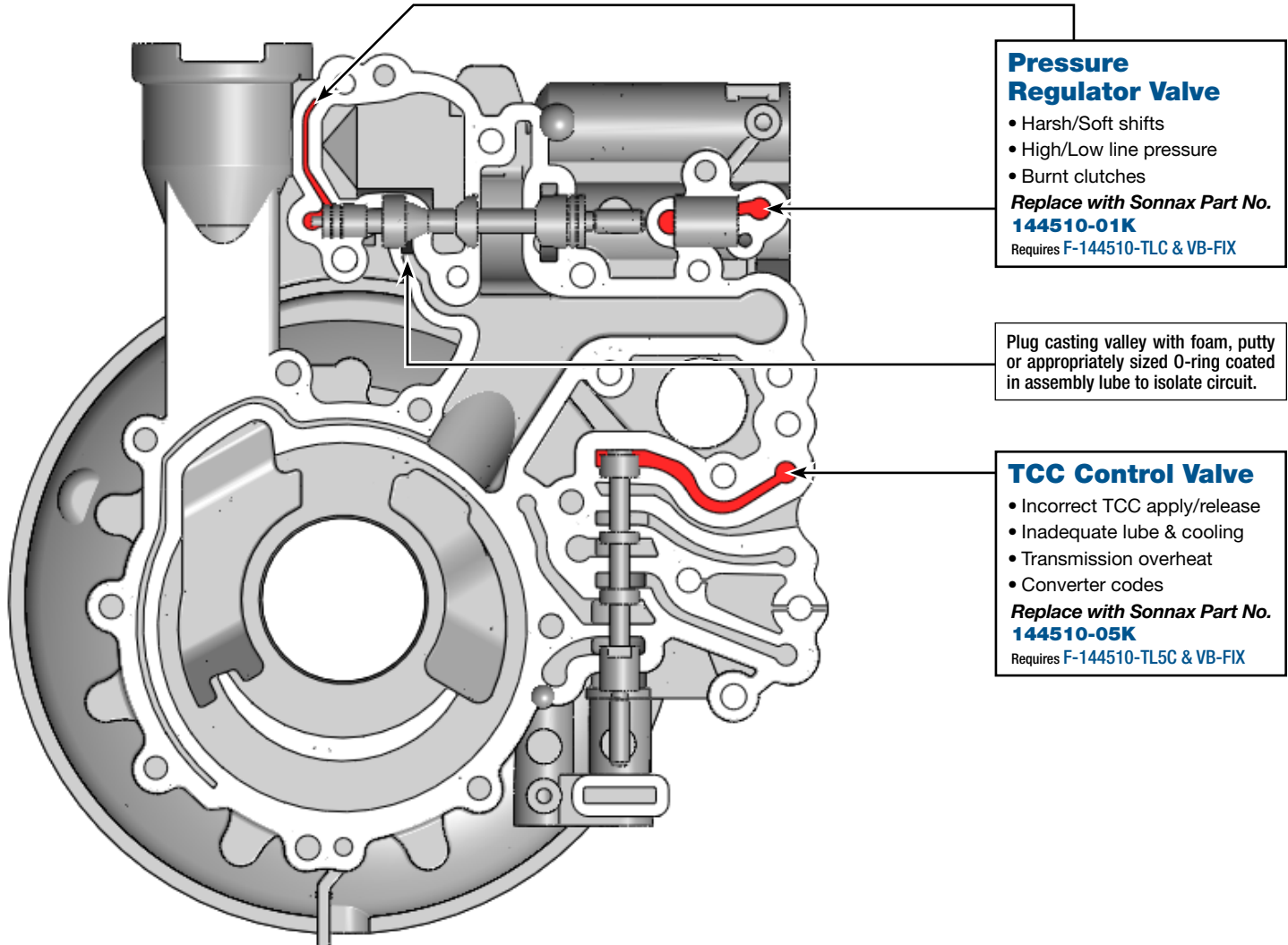

Pressure Regulator Valve

- Harsh/Soft shifts
- High/Low line pressure
- Burnt clutches

Replace with Sonnax Part No. **144510-01K**

Requires F-144510-TLC & VB-FIX

Plug casting valley with foam, putty or appropriately sized O-ring coated in assembly lube to isolate circuit.

TCC Control Valve

- Incorrect TCC apply/release
- Inadequate lube & cooling
- Transmission overheat
- Converter codes

Replace with Sonnax Part No. **144510-05K**

Requires F-144510-TL5C & VB-FIX

OE Exploded View

Control Valve Body • Gen. 1 6T40 Shown

NOTE: Depending upon vehicle application, the OE springs shown may not be present.

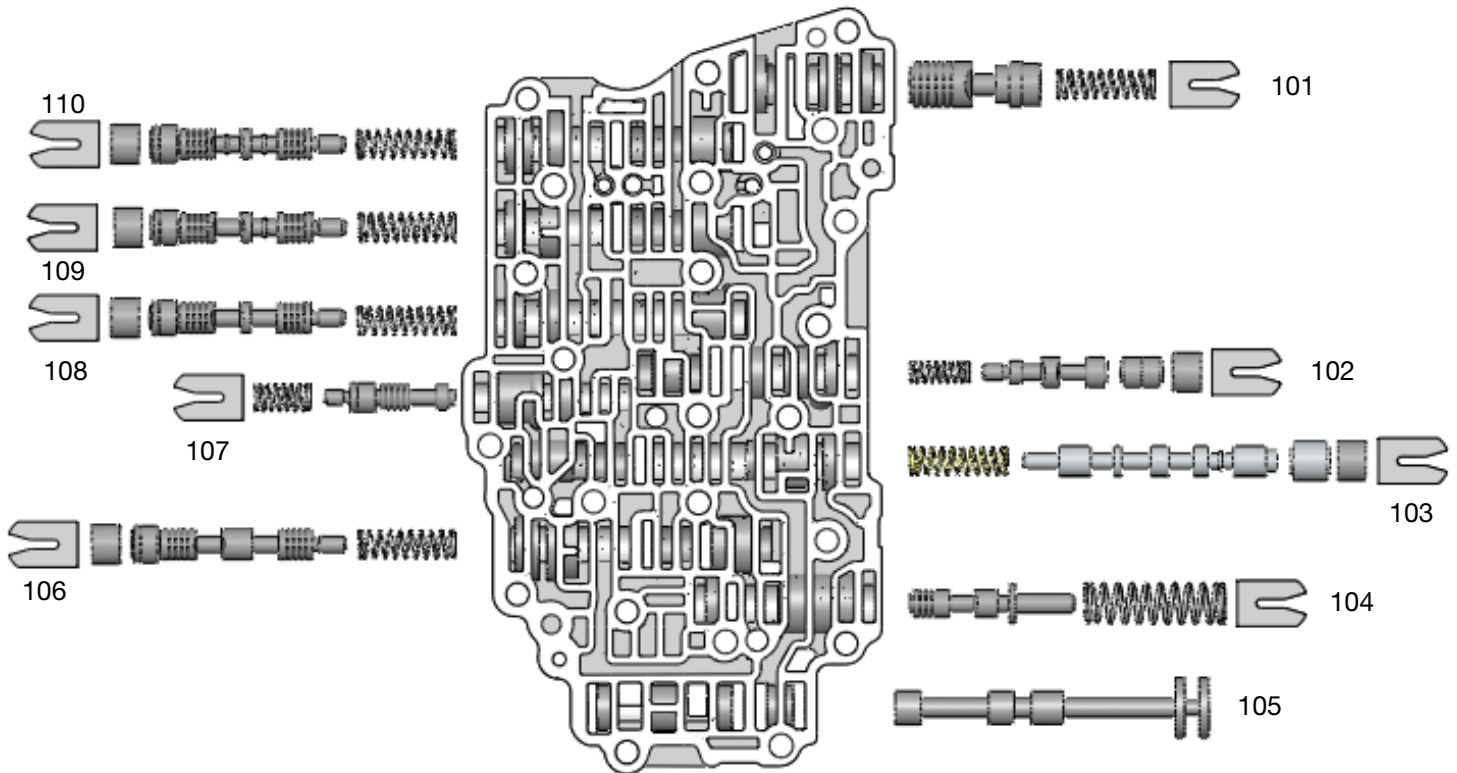

Control Valve Body Descriptions

I.D. No.	Description
101	Compensator Feed Limit Valve
102	TCC Regulator Apply Valve
103	Clutch Select Valve (inboard) Shuttle Valve (outboard)
104	Actuator Feed Limit Valve
105	Manual Valve
106	Reverse & 4-5-6 Clutch Regulator Valve
107	1-2-3-4 Clutch Boost Valve
108	1-2-3-4 Clutch Regulator Valve
109	2-6 Clutch Regulator Valve
110	3-5 Reverse Clutch Regulator Valve

OE Exploded View

Pump Body • Gen. 1 6T40 Shown

NOTE: Depending upon vehicle application, the OE springs shown may not be present.

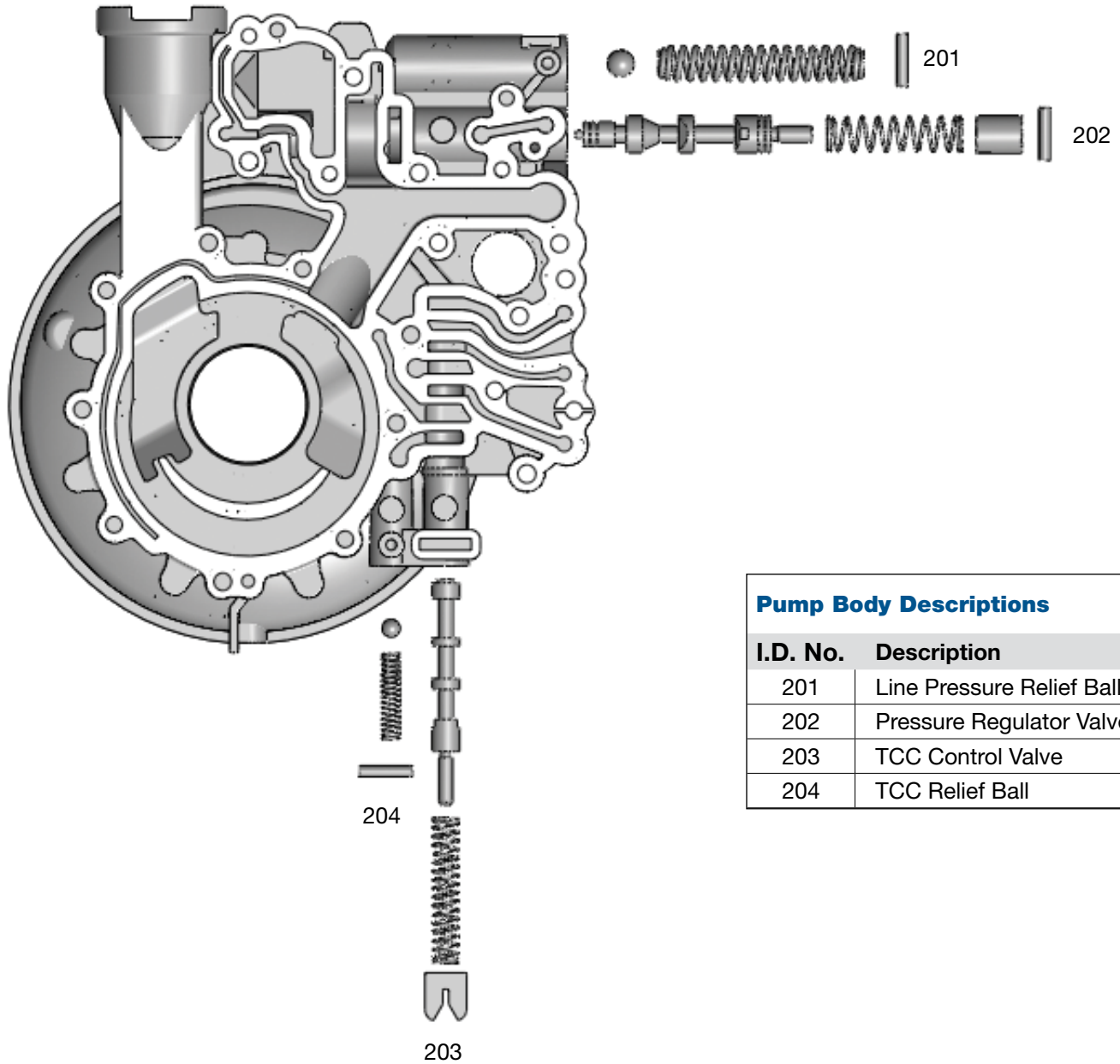

Pump Body Descriptions

I.D. No.	Description
201	Line Pressure Relief Ball
202	Pressure Regulator Valve
203	TCC Control Valve
204	TCC Relief Ball